



AA-0221-5

Operating Voltage = _____ 115/250 Vac
 Operating Current = _____ 5 Amp
 Operating Frequency = _____ 50/60Hz
 Operating Temperature = _____ -20°C to 50°C

Diel. Withstanding (Line—Case) = _____ 1500 Vac
 Diel. Withstanding (Line—Line) = _____ 1500 Vac

Leakage Current = _____ 0.5 mA @ 250 Vac, 60 Hz
 Max Residual Voltage after 1 Sec. = _____ 30 Volts

MTBF = _____ 422,726 Hrs @ 30°C GB

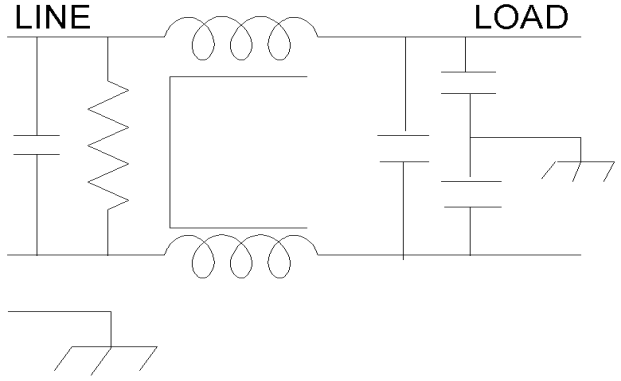

INSERTION LOSS vs. FREQUENCY

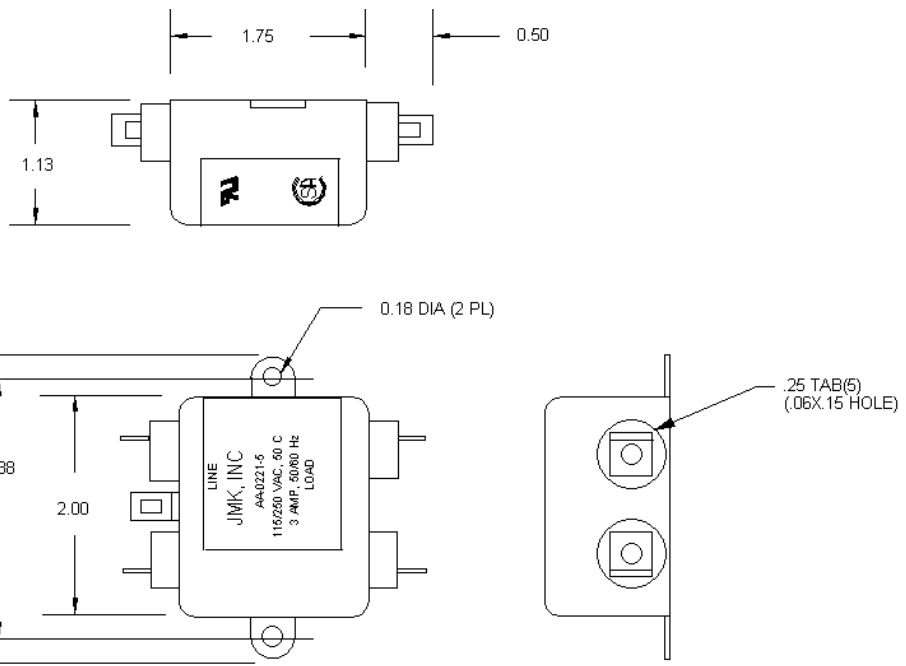
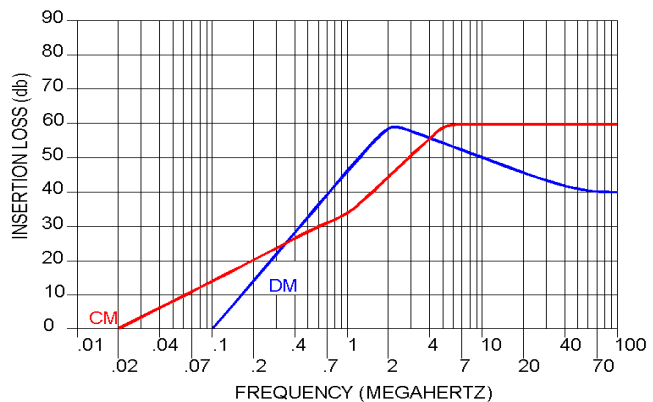

USA JMK Inc 15 Caldwell Dr. Amherst, NH 03031 PH: 603 886-4100 FX: 603 886-4115
 email: info@jmkfilters.com
 EUR JMK Inc Glasgow G13 1DN Scotland UK PH: 44-(0) 7785310729 Fax: 44-(0) 141 589 1884