



MF-0637A-60BR

This EMI / RFI filter features a very small mechanical package. Even with this small size the common mode insertion loss and differential loss are more than is available in other similarly sized packages.

This filter has additionally been designed to operate with severe unbalanced current loading. It can withstand up to a 30% unbalance in line and return without degrading the common mode insertion loss.

This capability is very useful when the filter is used in dual systems with shared returns.

This filter package is ruggedly designed to operate in automotive as well as tele-communication environments.

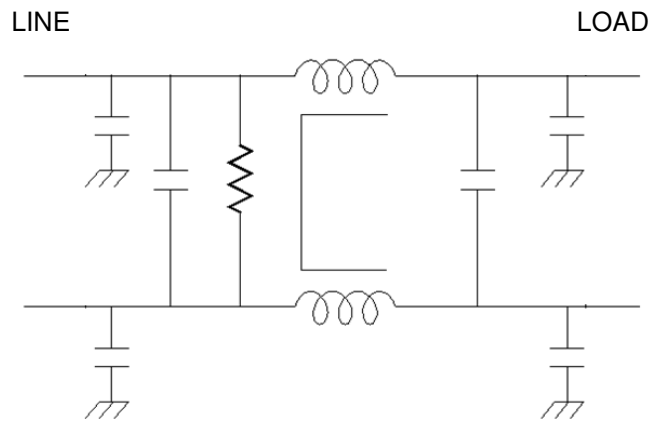

Operating Voltage = _____ 400 Vdc Max
 Operating Current = _____ 60 Amps
 Operating Temperature Range = _____ -40 to 50 °C

Dielectric Withstanding Voltage
 Line to Line: 707 Vdc for 1 minute
 Line to Case: 2250 Vdc for 1.0 min

Safety Agency Approval = CSA

Order P/N: MM-0637A-60BR

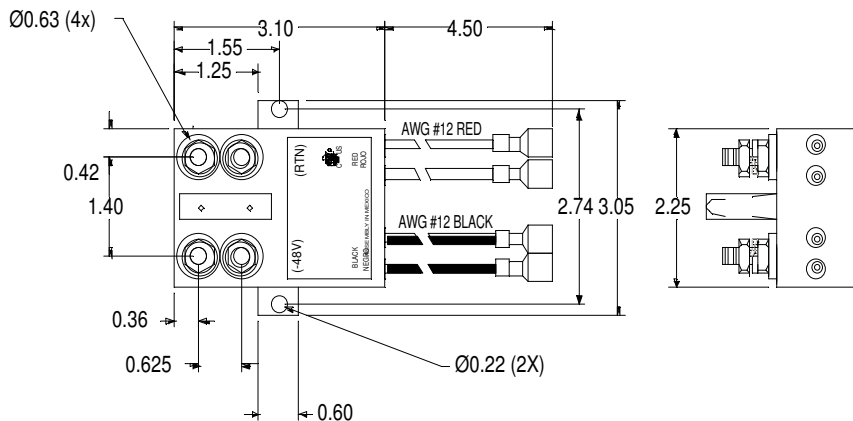
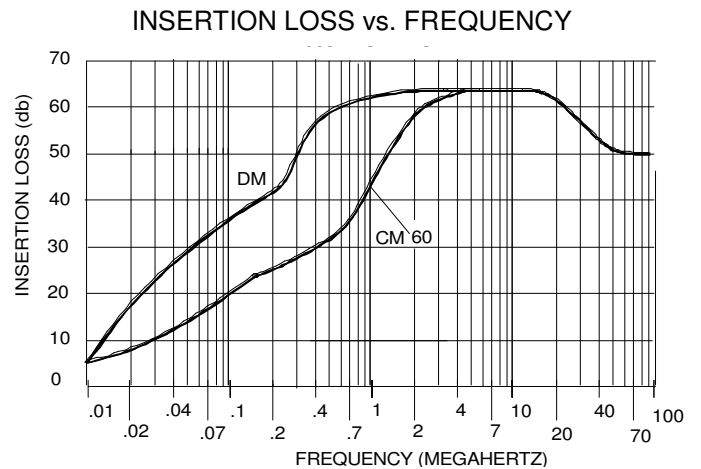

USA JMK Inc 15 Caldwell Dr. Amherst, NH 03031 PH: 603 886-4100 FX: 603 886-4115
 email: info@jmkfilters.com
 EUR JMK Inc Glasgow G13 1DN Scotland UK PH: 44-(0) 7785310729 Fax: 44-(0) 141 589 1884