

JMK, Inc.

EF-1366-10B

Performance Characteristics

Operating voltage: 125/250 Vac, 50/60 Hz
 125 Vac, 400 Hz
 Max. operating current: 10.0 ampere
 Operating temperature: -20—50°C
 Dielectric Withstand. Line/case: 1500 Vac. (1.0 minute)
 Dielectric Withstand. Line/Neut: 1500 Vdc. (1.0 minute)
 Capacitance, (Each line—case): 0.015 μ F Typ.
 Leakage current 125V, 60 Hz: 0.85 ma max
 125V, 400 Hz: 5.70 ma max
 250 V, 50 Hz: 1.45 ma max
 Varistor Voltage: 462—540 volts
 Weight: 1.0 lb.
 MTBF: 978,232 Hrs, RoHS compliant

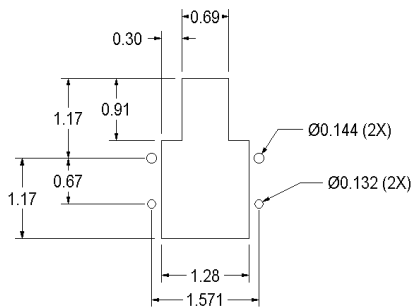
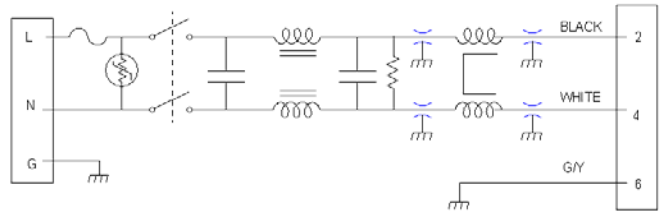

PANEL CUTOUT

INSERTION LOSS

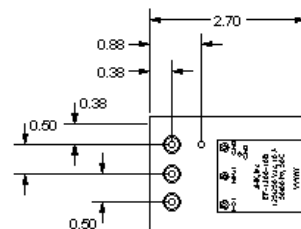
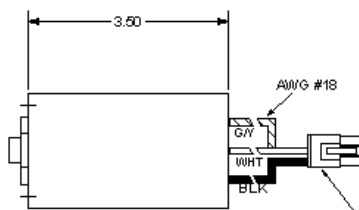
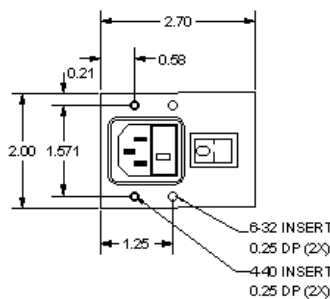
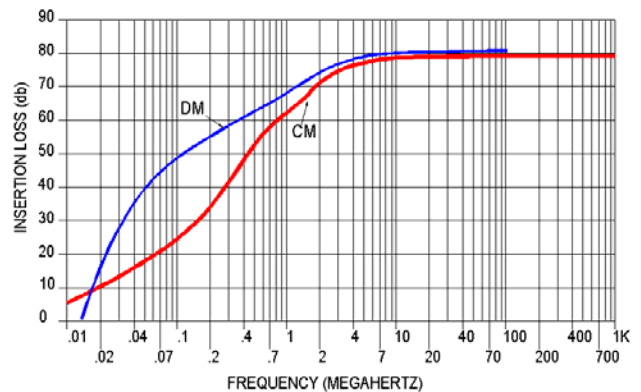

AMP P/N 172168-1 CONNECTOR WITH 170366-3 SOCKET CONTACTS

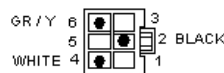
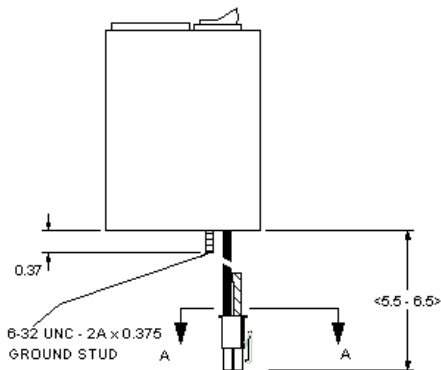

VIEW A-A

CABLE SIDE OF CONNECTOR

USA JMK Inc 15 Caldwell Dr. Amherst, NH 03031 PH: 603 886-4100 FX: 603 886-4115

email: info@jmkfilters.com

EUR JMK Inc (UK) Glasgow, Scotland UK PH: 44-(0) 7785310729 FX: 44-(0) 141 589-1884